

Z-1170 Pocket-Size Personal Data Collector



Standard Device

P/N	Model Name	Remark
881-110000-001	Z-1170, Device only	Without charging and wireless function
881-1100R9-101	Z-1170 with RS-232 cable	RS-232 cable included
881-1100UH-101	Z-1170 with USB-HID cable	USB Cable included
881-1100UR-101	Z-1170 with USB-232 cable	USB-232 cable included
881-11BTC0-001	Z-1170BT V2C, Device only	With charging and wireless function
881-11BCR9-101	Z-1170BT V2C with RS232 Cable	RS-232 cable included
881-11BCUH-101	Z-1170BT V2C with USB Cable	USB-HID cable included
881-11BCUR-101	Z-1170BT V2C with USB-232 Cable	USB-232 cable included



Standard Accessory

Description	Hand Strap	
Barcode	P/N	Remark
	623-210700-041	Hand strap



[Buyer's Guide]

Standard Cable

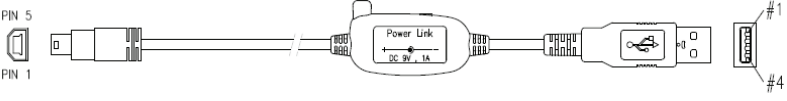

1. Mini USB B/RS-232 Cable

	PIN-OUT CONFIGURATION			
	DB-9(F)		MINI USB	
	2.	TxD	1.	9V
	3.	RxD	2.	RxD
	5.	GND	3.	TxD
	DC-IN	9V	4.	~Online
		5.	GND	
Item Part No.	170-00R049-180			

2. HID USB cable

	PIN-OUT CONFIGURATION			
	USB A TYPE		MINI USB	
	1.	Vcc+	1	9V
	2.	D-	2	RxD
	3	D+	3	TxD
	4	GND	4	~Online
		5	GND	
Item Part No.	170-00U329-200			

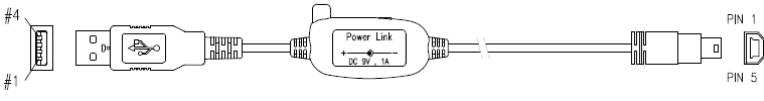
3. USB-232 Charging to PC Cable

	PIN-OUT CONFIGURATION			
	USB A TYPE		MINI USB	
	1.	Vcc+	1	9V
	2.	D-	2	RxD
	3	D+	3	TxD
	4	GND	4	~Online
		5	GND	
Item Part No.	170-00R319-150			

[Buyer's Guide]

Optional Accessory

Description	Ni-NH Battery AAA battery	
Barcode	P/N	Remark
	862-203000-K01	Ni-NH Battery AAA battery

Description	Wireless BT Charger	
Barcode	P/N	Remark
	881-70CR00-001	For models with wireless charging functions

Power Adapter

ZEBEX provides adapters of the following plug types:

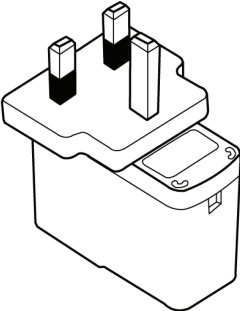
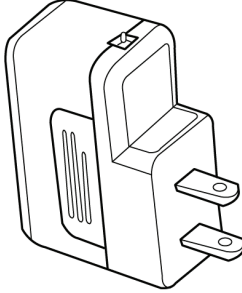
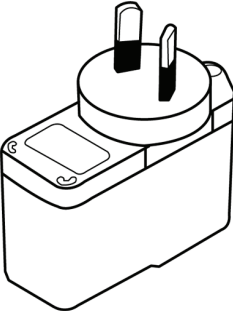
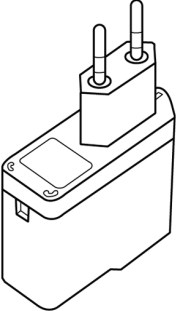
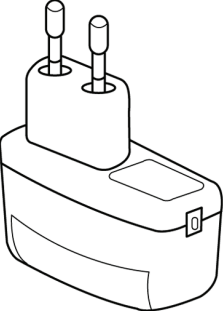
UK Plug	US Plug	Australian Plug	European Plug	Korean Plug
				

* The figures are for reference only. The adaptor form factor is subject to change without prior notice.