

[Buyer's Guide]

Z-2121 Advanced Portable Data Collector





Standard Device



P/N	Model Name	Remark
882-210000-001	Z-2121,Device Only	Z-2121,1D Laser, Device Only
882-2100CR-101	Z-2121 w/RS232 Cradle	Z-2121 Portable Laser Data Collector, w/RS232 Cradle
882-2100CU-101	Z-2121 w/USB Cradle	Z-2121 Portable Laser Data Collector, w/USB Cradle
882-2100R9-101	Z-2121 w/RS232 Cable	Z-2121 Portable Laser Data Collector, w/RS232 Cable
882-2100UB-101	Z-2121 w/USB Cable	Z-2121 Portable Laser Data Collector, w/USB Cable

Accessory

Description	Battery		
Barcode	P/N	Remark	
	191-908304-200	Rechargeable Li-ion battery	



Description	RS-232 Cradle		
Barcode	P/N	Remark	
	882-21CRR9-001	Communication and charging cradle	
	170-61R429-180	CABLE RS232,BLACK,DC 9V input,180cm to CRD-21	
	11S-900180-038	Adapter for cradle (no plug)	

[Buyer's Guide]

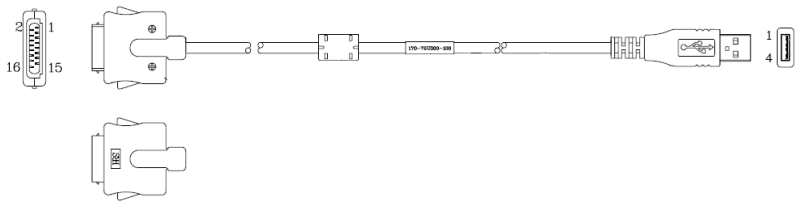

Description	USB Cradle		
Barcode	P/N	Remark	
	882-21CRUB-001	Communication and charging cradle	
	11S-900180-038	Adapter for cradle (no plug)	

Standard Cable

1. USB Cable

	PIN-OUT CONFIGURATION			
	16 Pin Connector		USB Type A	
	1	USB 5V	1	VCC
	9	GND	2	D-
	10	GND	3	D+
	11	GND	4	GND
	14	USB 5V		
	15	USB N (D-)		
16	USB P (D+)			
Item Part No.	170-71U300-180			

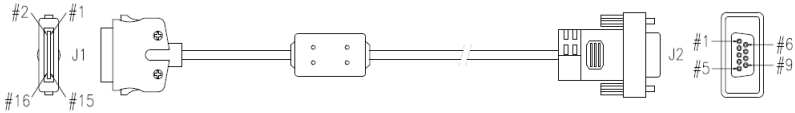
2. RS-232 cable

	PIN-OUT CONFIGURATION			
	16 Pin Connector		DB-9(F)	
	2	DCD	1	DCD
	3	DSR	2	RXD
	4	CTS	3	TXD
	5	RXD	4	DTR
	6	DTR	5	CND
	7	RTS	6	DSR
	8	TXD	7	RTS
	9	GND	8	CTS
	10	GND	9	RI
	11	GND		
	12	DC-in (9V)	DC-in	9V
	13	DC-in (9V)		
Item Part No.	170-74R449-150			

[Buyer's Guide]

Power Adapter

ZEBEX provides adapters of the following plug types:

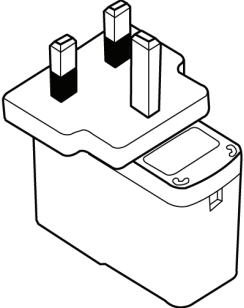
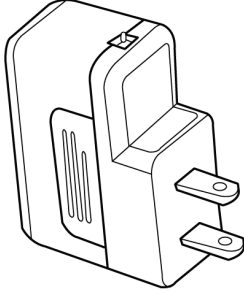
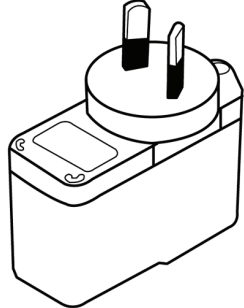
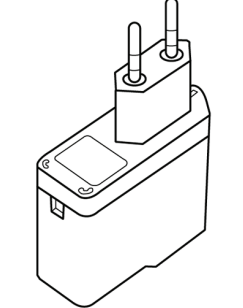
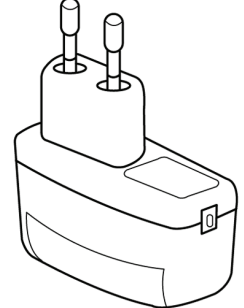
UK Plug	US Plug	Australian Plug	European Plug	Korean Plug
				

* The figures are for reference only. The adaptor form factor is subject to change without prior notice.