

[Buyer's Guide]

Z-3392BT Plus Gun Type Wireless 2D Image Handheld Scanner

Device Pin-Out

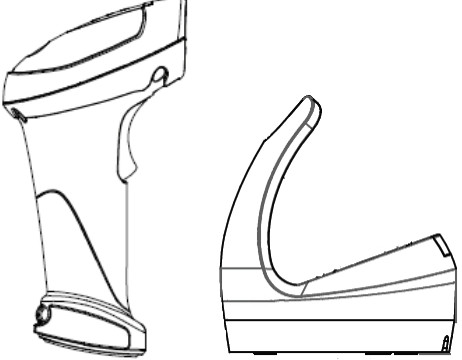

	MINI USB PIN-OUT CONFIGURATION			
	SCANNER		CRADLE	
	PIN 1.	+5V	PIN 1.	+5V
	PIN 2.	USB_D-	PIN 2.	NC
	PIN 3.	USB_D+	PIN 3.	NC
	PIN 4.	NC	PIN 4.	NC
	PIN 5.	GND	PIN 5.	GND
	CRADLE PHONE JACK PIN-OUT CONFIGURATION			
	RJ 1.	RTS_EIA	RJ 6.	RX_EIA
	RJ 2.	KB Data / USB_D+	RJ 7.	KB Clock
RJ 3.	PC Clock / USB_D-	RJ 8.	+5V	
RJ 4.	GND	RJ 9.	PC Data	
RJ 5.	CTS_EIA	RJ10.	TX_EIA	

P/N	Model Name	Remark
88H-39BP00-001	Z-3392BT Plus (B)	Gun Type Wireless 2D Image Handheld Scanner Black USB BA
88H-39BPUB-AC1	Z-3392BT Plus (U)(B)(CR)	Gun Type Wireless 2D Image Handheld Scanner Black USB Cradle AU adapter BA
88H-39BPUB-EC1	Z-3392BT Plus (U)(B)(CR)	Gun Type Wireless 2D Image Handheld Scanner Black USB Cradle EU adapter BA
88H-39BPUB-KC1	Z-3392BT Plus (U)(B)(CR)	Gun Type Wireless 2D Image Handheld Scanner Black USB Cradle UK adapter BA
88H-39BPUB-UC1	Z-3392BT Plus (U)(B)(CR)	Gun Type Wireless 2D Image Handheld Scanner Black USB Cradle US adapter BA
88H-39BPRP-AC1	Z-3392BT Plus (R)(B)(CR)	Gun Type Wireless 2D Image Handheld Scanner Black RS232 Cradle AU adapter BA
88H-39BPRP-EC1	Z-3392BT Plus (R)(B)(CR)	Gun Type Wireless 2D Image Handheld Scanner Black RS232 Cradle EU adapter BA
88H-39BPRP-KC1	Z-3392BT Plus (R)(B)(CR)	Gun Type Wireless 2D Image Handheld Scanner Black RS232 Cradle UK adapter BA
88H-39BPRP-UC1	Z-3392BT Plus (R)(B)(CR)	Gun Type Wireless 2D Image Handheld Scanner Black RS232 Cradle US adapter BA
88H-39BPKP-AC1	Z-3392BT Plus (K)(B)(CR)	Gun Type Wireless 2D Image Handheld Scanner Black PS/2 Cradle AU adapter BA
88H-39BPKP-EC1	Z-3392BT Plus (K)(B)(CR)	Gun Type Wireless 2D Image Handheld Scanner Black PS/2 Cradle EU adapter BA
88H-39BPKP-KC1	Z-3392BT Plus(K)(B)(CR)	Gun Type Wireless 2D Image Handheld Scanner Black PS/2 Cradle UK adapter BA
88H-39BPKP-UC1	Z-3392BT Plus(K)(B)(CR)	Gun Type Wireless 2D Image Handheld Scanner Black PS/2 Cradle US adapter BA

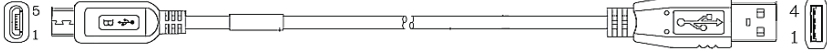

[Buyer's Guide]

Standard Accessory



Description	Lithium-Ion Battery		
Barcode	P/N	Remark	
	191-B25004-201	3.7V, 2500mAH	

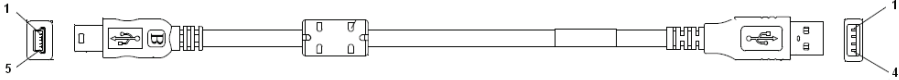





Description	Micro USB Cable			
	PIN-OUT CONFIGURATION			
	Micro USB		USB A TYPE	
	1.	5V	1	VCC+
	2.	D-	2	D-
	3.	D+	3	D+
	4.		4	GND
5.	GND			
Item Part No.	170-15U302-150			

Optional Accessory

Description	Mini USB B to USB A Cable			
	PIN-OUT CONFIGURATION			
	Micro USB		USB A TYPE	
	1.	5V	1	VCC+
	2.	D-	2	D-
	3.	D+	3	D+
	4.		4	GND
5.	GND			
Item Part No.	173-0U0002-150			
	173-0U0003-150			

[Buyer's Guide]

Description	RS-90, Communication & Charging Cradle	
Barcode	P/N	Remark
	88H-90RSZT-020	White Housing, Metal Base
	88H-90RSZT-021	Black Housing, Metal Base

Description	USB AC Adaptor (5V 1A)	
Barcode	P/N	Remark
	11S-500001-90A	Adaptor w/US plug
	11S-500001-91A*	Adaptor w/US plug *US area*
	11S-500003-90A	Adaptor w/European plug
	11S-500000-028	Universal adaptor w/o plug
	11S-000002-00B	Australian plug for universal adaptor
	11S-000000-008	UK plug for universal adaptor

Description	Cable Clip	
Barcode	P/N	Remark
	572-050000-411	Clip for Mini USB Cable

Description	Hand Strip	
Barcode	P/N	Remark
	623-2Z9000-001	Hand Strip

Battery Recharging

Z-3392BT Plus uses one li-ion battery for wireless operation and the battery has to be charged within the scanner. Users should always use the original battery and charging equipments provided by the ZEBEX to avoid any non-compatible danger or void the warranty,



There are three methods of recharging the battery.

1. Use a micro USB cable to connect the scanner with a host's USB port. The battery is charged by the host.
2. Use a micro USB cable and a USB AC adaptor to connect the scanner with socket on wall. The battery is charged by the socket.
3. Put the scanner on cradle and connect the cradle and host with an interface cable. The battery is charged by the cradle.

Standard Cable Options

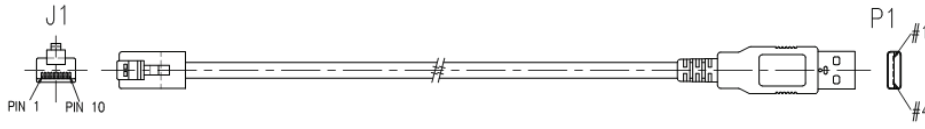

- The standard interface cable options of cradle include USB, RS-232, and PS/2 cable.
- The standard interface cable of cradle is black, straight, and 3 meters (9.8 feet) in length.
- Special Order Requirement:
ZEBEX is capable of supplying special customized cables, given that customers provide detailed pin configurations. Please contact your sales representative to further discuss the minimum order quantity of the special cables.

1. USB / Virtual COM USB with Detachable Cable Type A

		USB TYPE A CONNECTOR		FUNCTION
		1.		VCC
		2.		D-
		3.		D+
		4.		VSS
Item Part No.	170-15U301-300			

* Additional software installation may be necessary for activating virtual COM USB interface.

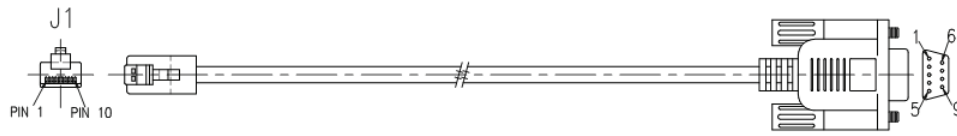
2. RS-232 Cable (DTE pin out)

		PIN-OUT CONFIGURATION	
		DB-9 (F)	FUNCTION
		2	TX
		3	RX
		7	CTS
		8	RTS
5	GND		
Item Part No.	170-15R422-300		

3. Keyboard Wedge Cable (for PS/2)

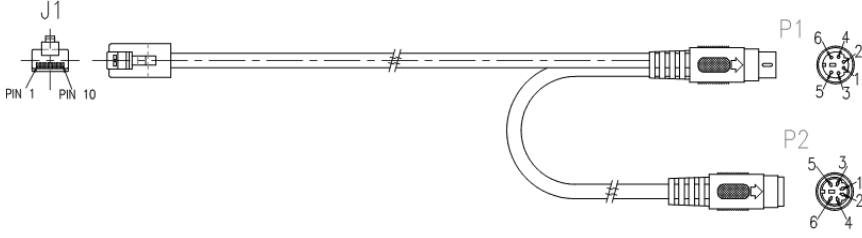
		PIN-OUT CONFIGURATION			
		MINI DIN (M)		MINI DIN (F)	
		DIN	FUNCTION	DIN	FUNCTION
		1.	PC Data	1.	KB Data
		2.	N.C.	2.	N.C.
		3.	GND	3.	GND
		4.	+5V	4.	+5V
		5.	PC Clock	5.	KB Clock
6.	N.C.	6.	N.C.		
Item Part No.	170-15K100-300	