











Z-3392 Plus Series Gun Type 2D Image Handheld Scanner

Standard Device

		PIN-OUT CONFIGURATION			
		RJ 1.	RTS	RJ 2.	USB+
		RJ 3.	USB-	RJ 4.	GND
		RJ 5.	CTS	RJ 6.	RXD
		RJ 7.	NC	RJ 8.	+5V
		RJ 9.	NC	RJ 10.	TXD
Barcode	P/N	Model Name	Remark		
	88H-39PLUB-001	Z-3392 Plus (U)(B)	Gun Type 2D Image Handheld Scanner, Black, USB cable		
	88H-39PLUB-0S1	Z-3392 Plus(U)(B)	Gun Type 2D Image Handheld Scanner Black USB Stand		
	88H-39PLRP-001	Z-3392 Plus(R)(B)	Gun Type 2D Image Handheld Scanner Black RS232		
	88H-39PLRP-0S1	Z-3392 Plus(R)(B)	Gun Type 2D Image Handheld Scanner Black RS232 Stand		
	88H-390PLRP-A01	Z-3392 Plus(R)(B)	Gun Type 2D Image Handheld Scanner Black RS232 AU adapter		
	88H-39PLRP-E01	Z-3392 Plus(R)(B)	Gun Type 2D Image Handheld Scanner Black RS232 EU adapter		
	88H-39PLRP-K01	Z-3392 Plus(R)(B)	Gun Type 2D Image Handheld Scanner Black RS232 UK adapter		
	88H-39PLRP-U01	Z-3392 Plus(R)(B)	Gun Type 2D Image Handheld Scanner Black RS232 US adapter		

[Buyer's Guide]



Optional Accessory

	Description		Stand for Z-319X Series	
	Barcode		P/N	Remark
			88H-90ST00-000	White Housing
			88H-90ST00-001	Black Housing
			88H-90ST00-0NB	White Housing w/o ZEBEX logo
		88H-90ST00-0N1	Black Housing w/o ZEBEX logo	

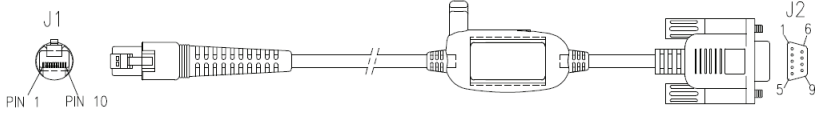

Cable Options

- The standard cable is gray, straight, and 2 meters (6.5 feet) in length.
- The standard cable options include RS-232 and USB.
- Special Order Requirement:
ZEBEX is capable of supplying special customized cables, given that customers provide detailed pin configurations. Please contact your sales representative to further discuss the minimum order quantity of the special cables.

1. RS-232C Communication Cable (DTE pin out)

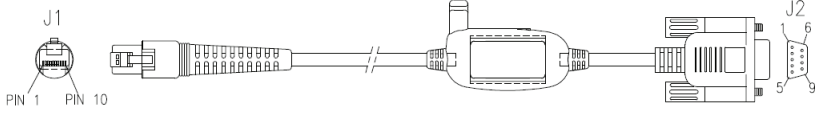

		DB-9 (F)		FUNCTION
		2		TX
		3		RX
		7		CTS
		8		RTS
		5		GND
9		+5V Input		
Item Part No.	171-10R442-200			

2. RS-232C Communication Cable (DCE pin out) (non-standard option)

		PIN-OUT CONFIGURATION		
		DB-9 (F)		FUNCTION
		2		RX
		3		TX
		7		RTS
		8		CTS
5		GND		
9		+5V Input		
Item Part No.	171-10R432-200			
Item Part No.	171-10R433-200			

[Buyer's Guide]

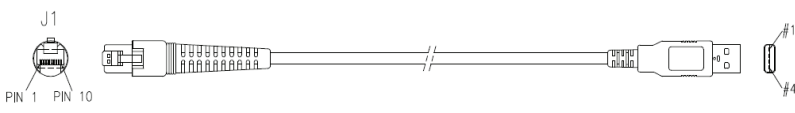
3. USB Cable

		USB TYPE A CONNECTOR	FUNCTION
		1.	VCC
		2.	D-
		3.	D+
		4.	VSS
Item Part No.	171-10U302-200		
	171-10U303-200		

Power Adapter

Z-3392 Plus requires a minimum of 250mA at 5 VDC power and consumes power from the host machine. If the host can not supply sufficient power, ZEBEX provides adapters of the following plug types:

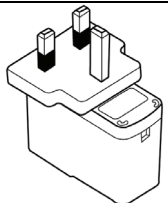
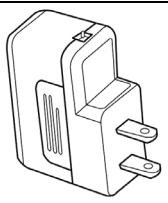
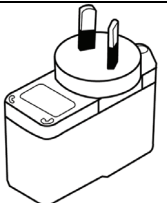
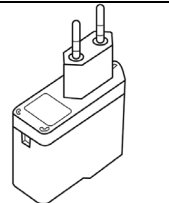
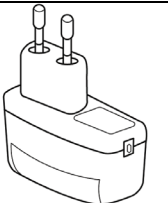
UK Plug	US Plug	Australian Plug	European Plug	Korean Plug
				

* The figures are for reference only. The adaptor form factor is subject to change without prior notice.