

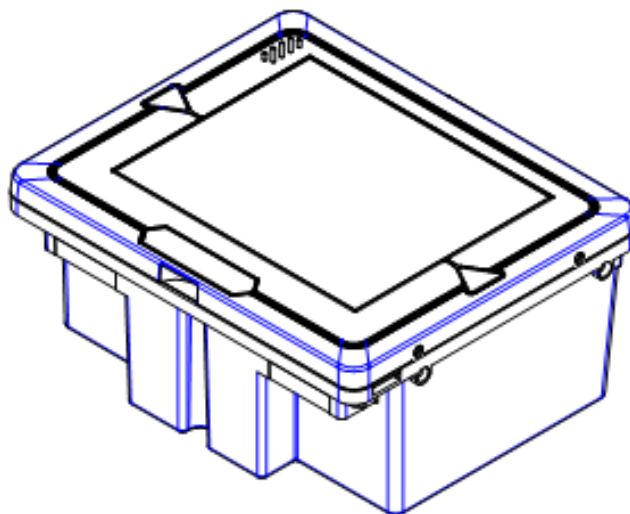

Z-6181 Dual-Laser Omnidirectional In-Counter Scanner

Standard Device



Product Number

Barcode	P/N	Model Name	Remark
	88N-8100KP-001	Z-6181(K)	Standard Device w/PS/2 cable
	88N-8100RP-001	Z-6181(R)	Standard Device w/RS-232 cable
	88N-8100UB-001	Z-6181(U)	Standard Device w/USB cable

Standard Accessory

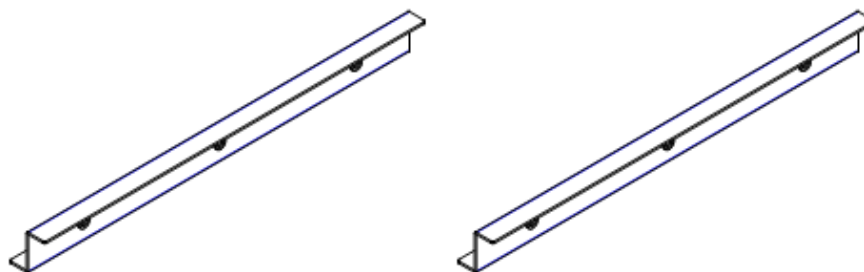



Description	Mounting Kits for Z-6180/Z-6181		
Barcode	P/N	Remark	
	88N-80MK00-000	2 Fixing plates and 6 screws	

[Buyer's Guide]

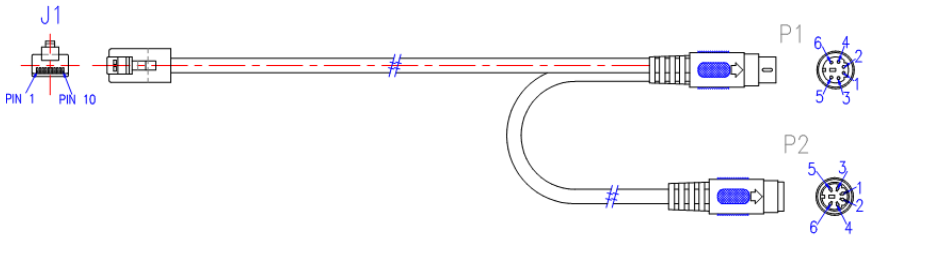

Standard Cable Options

- The standard cable is black, straight, and 3 meters (10 feet) in length.
- The standard cable options include PS/2, RS-232, HID USB, virtual COM USB, and etc..
- Special Order Requirement:
ZEBEX is capable of supplying special customized cable, given that customers provide detailed pin configurations. The minimum order quantity of a special cable is 250 pcs.

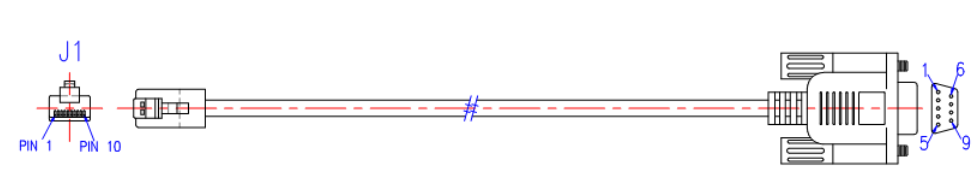

1. Keyboard Wedge Cable (for PS/2)

		PIN-OUT CONFIGURATION			
		MINI DIN (M)		MINI DIN(F)	
DIN	FUNCTION	DIN	FUNCTION		
1.	PC Data	1.	KB Data		
2.	N.C.	2.	N.C.		
3.	GND	3.	GND		
4.	PC 5V	4.	PC 5V		
5.	PC Clock	5.	KB Clock		
6.	N.C.	6.	N.C.		
Item Part No.	170-15K100-300				

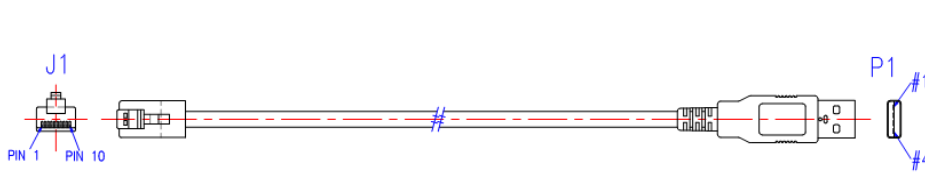

2. RS-232 Cable

		PIN-OUT CONFIGURATION			
		DB-9 (F)	FUNCTION		
Item Part No.		2	TX		
		3	RX		
		7	CTS		
		8	RTS		
		5	GND		
170-15R420-300					

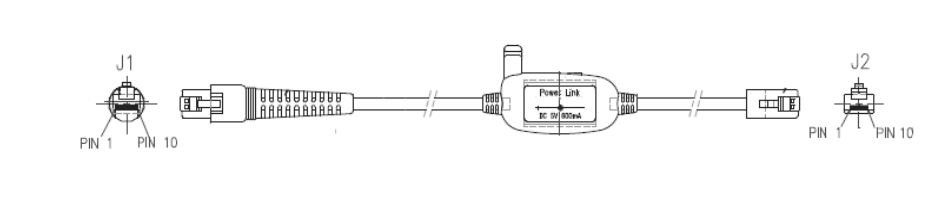

3. HID USB / Virtual COM USB Cable

		USB TYPE A CONNECTOR	FUNCTION		
		1.	VCC		
Item Part No.		2.	D-		
		3.	D+		
		4.	VSS		
		170-15U301-300			

4. AUX Cable

		RJ-69 CONNECTOR	FUNCTION		
		5	GND		
Item Part No.		4	CTS		
		6	RX		
		9	RTS		
		7	TX		
171-10RF45-200					

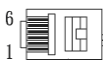
5. EAS Cable

		RJ12 6P6C	FUNCTION
		2	ANT+
		3	ANT-
Item Part No.	160-102002-000		

Power Supply

The power supply provides +12 volts, -12 volts and +5 volts DC voltage to the scanner; the detailed power requirement is as below:

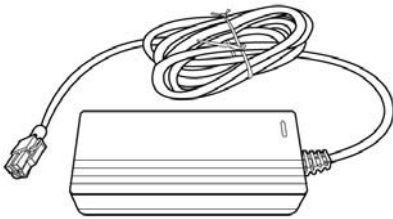



Voltage	AC100~240
Frequency	50~60HZ
Current (RMS)	600mA
Output	+5V,+12V,-12V

Barcode	P/N	Remark
	11S-51220N-909	Power supply(+5V,±12V),100~240V

Power Cord

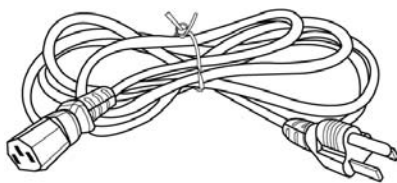
A country specific power cord is required to connect the electrical outlet and power supply. Select the proper IEC power cord for your country.



Barcode	P/N	Remark
	161-004011-800	Power cord, US plug, 3 pin, 180cm
	161-001021-800	Power cord, AC/IEC/EU plug, 2 pin, 180cm

* Use only an AC/DC power supply approved for the scanner. Use of other power supplies may cause damage to the product, and void the factory warranty.