

[Buyer's Guide]

Z-8082 2D Image On-Counter Scanner

Standard Device

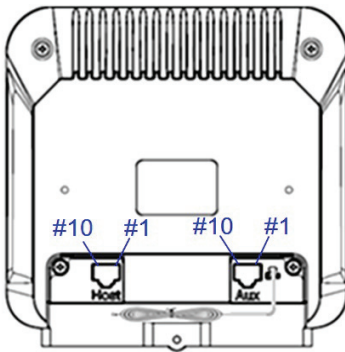
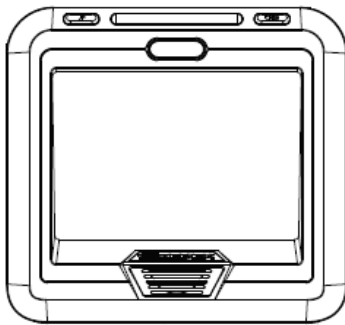

Pin	RS-232C	USB
1	N.C.	USB Power
2	+9V	
3	N.C.	D-
4	RTS_TTL	N.C.
5	Ground	
6	TXD_TTL	N.C.
7	RXD_TTL	N.C.
8	N.C.	D+
9	CTS_TTL	N.C.
10	N.C.	N.C.

Auxiliary Port	
Pin	Function
1	RX_TTL
2	N.C.
3	+5V output, 300mA max.
4	RTS_R
5	Ground
6	TX_R
7	RX_R
8	N.C.
9	CTS_R
10	TX_TTL

Ordering Information



Barcode	P/N	Model Name	Remark
	88N-0800UB-001	Z-8082(U)	2D Image On-Counter Scanner USB
	88N-0800UB-A01	Z-8082(U)	2D Image On-Counter Scanner USB AU adapter
	88N-0800UB-E01	Z-8082(U)	2D Image On-Counter Scanner USB EU adapter
	88N-0800UB-K01	Z-8082(U)	2D Image On-Counter Scanner USB UK adapter
	88N-0800UB-U01	Z-8082(U)	2D Image On-Counter Scanner USB US adapter
	88N-0800RP-A01	Z-8082(R)	2D Image On-Counter Scanner RS232 AU adapter
	88N-0800RP-E01	Z-8082(R)	2D Image On-Counter Scanner RS232 EU adapter
	88N-0800RP-K01	Z-8082(R)	2D Image On-Counter Scanner RS232 UK adapter
	88N-0800RP-U01	Z-8082(R)	2D Image On-Counter Scanner RS232 US adapter

[Buyer's Guide]

Standard Cable Options

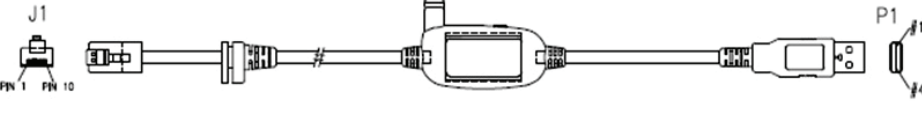

- The standard cable is gray, straight, and 2 meters (6.5 feet) in length.
- The standard cable options include USB and RS-232.
- Special Order Requirement:
ZEBEX is capable of supplying special customized cables, given that customers provide detailed pin configurations. Please contact your sales representative to further discuss the minimum order quantity of the special cables.

1. HID USB / USB Virtual COM Cable

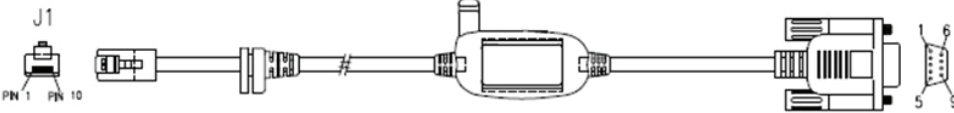

		USB TYPE A CONNECTOR	FUNCTION
		1	VCC
Item Part No.		171-43U316-200	
		171-43U318-200	

- Additional software and special firmware may be required for activating USB virtual COM interface.

2. RS-232C Cable

DTE Pin-Out 		DB-9 (F)	FUNCTION
		2	TX
Item Part No.		3	RX
		7	CTS
		8	RTS
		5	GND
			

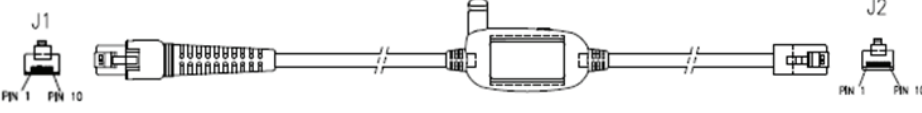
3. AUX Cable

		RJ-69 CONNECTOR	FUNCTION
		5	GND
Item Part No.		4	CTS
		6	RX
		9	RTS
		7	TX
			

- For connecting ZEBEX handheld scanners.

Power Adapter

Z-8082 requires a minimum of 250 mA at 9 VDC power and consumes power from the host machine. If the host can not supply sufficient power, ZEBEX provides adapters of the following plug types:

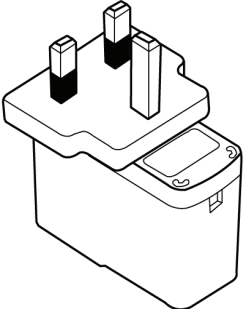
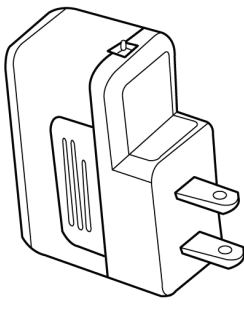
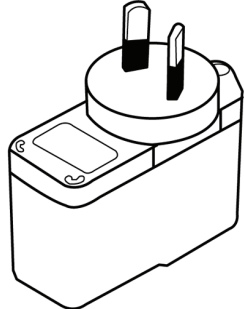
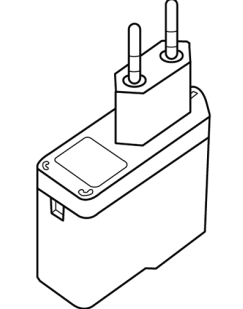
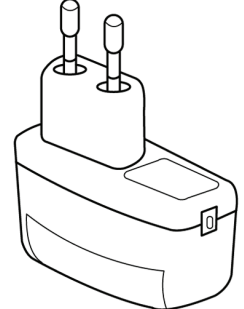
UK Plug	US Plug	Australian Plug	European Plug	Korean Plug
				

* The figures are for reference only. The adaptor form factor is subject to change without prior notice.